

Pompownia Tczew

Załącznik nr 6a.
Do Zaprośzenia DOT-ZOT.260.41.1.2021.RG

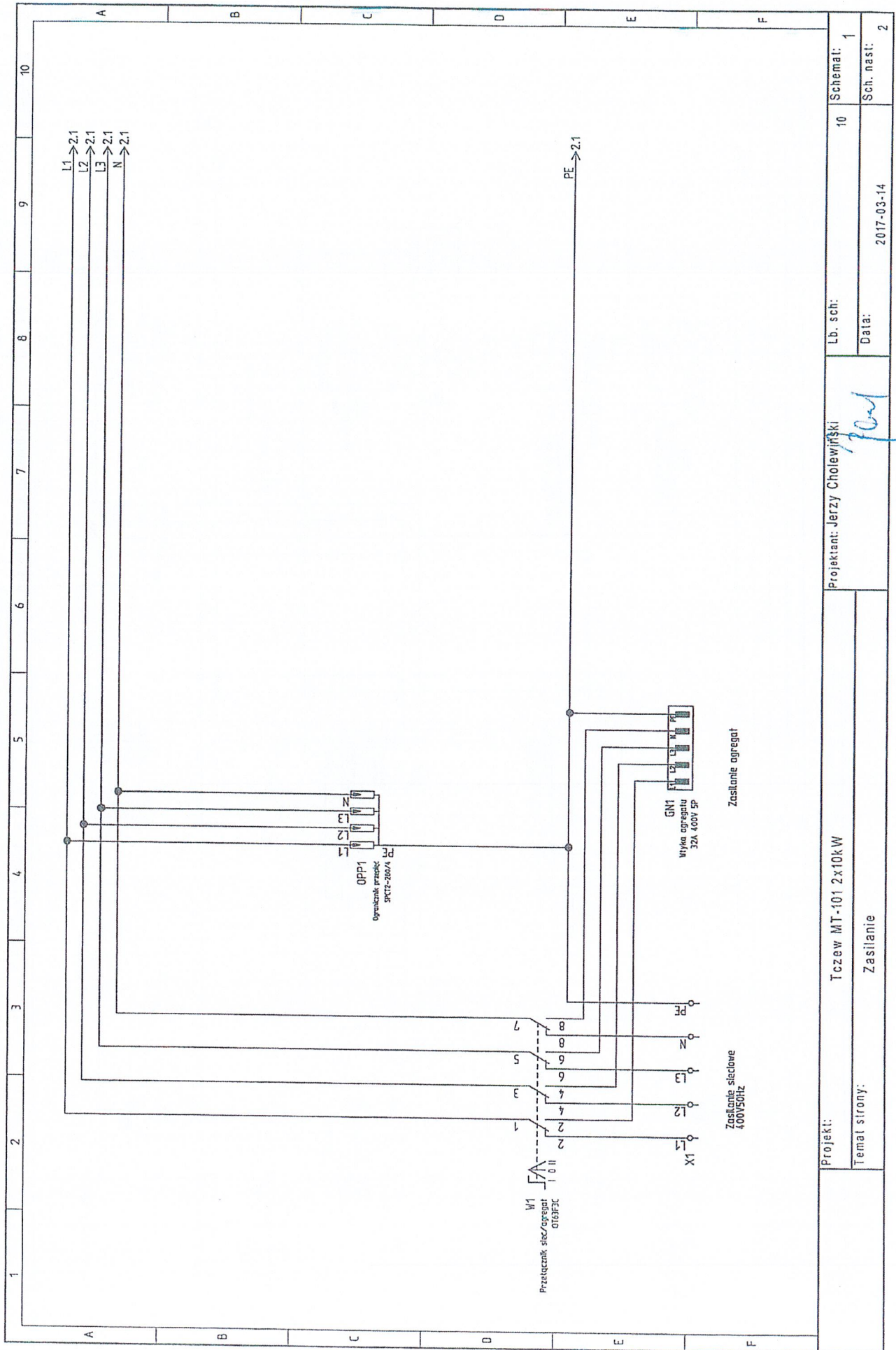

Projekt: Tczew MT-101 2x10kW Temat strony: Zasilanie	Projektant: Jerzy Cholewiński		Lb. sch.: 10	Schemat: 1
	Data: 2017-03-14		Sch. nast: 2	

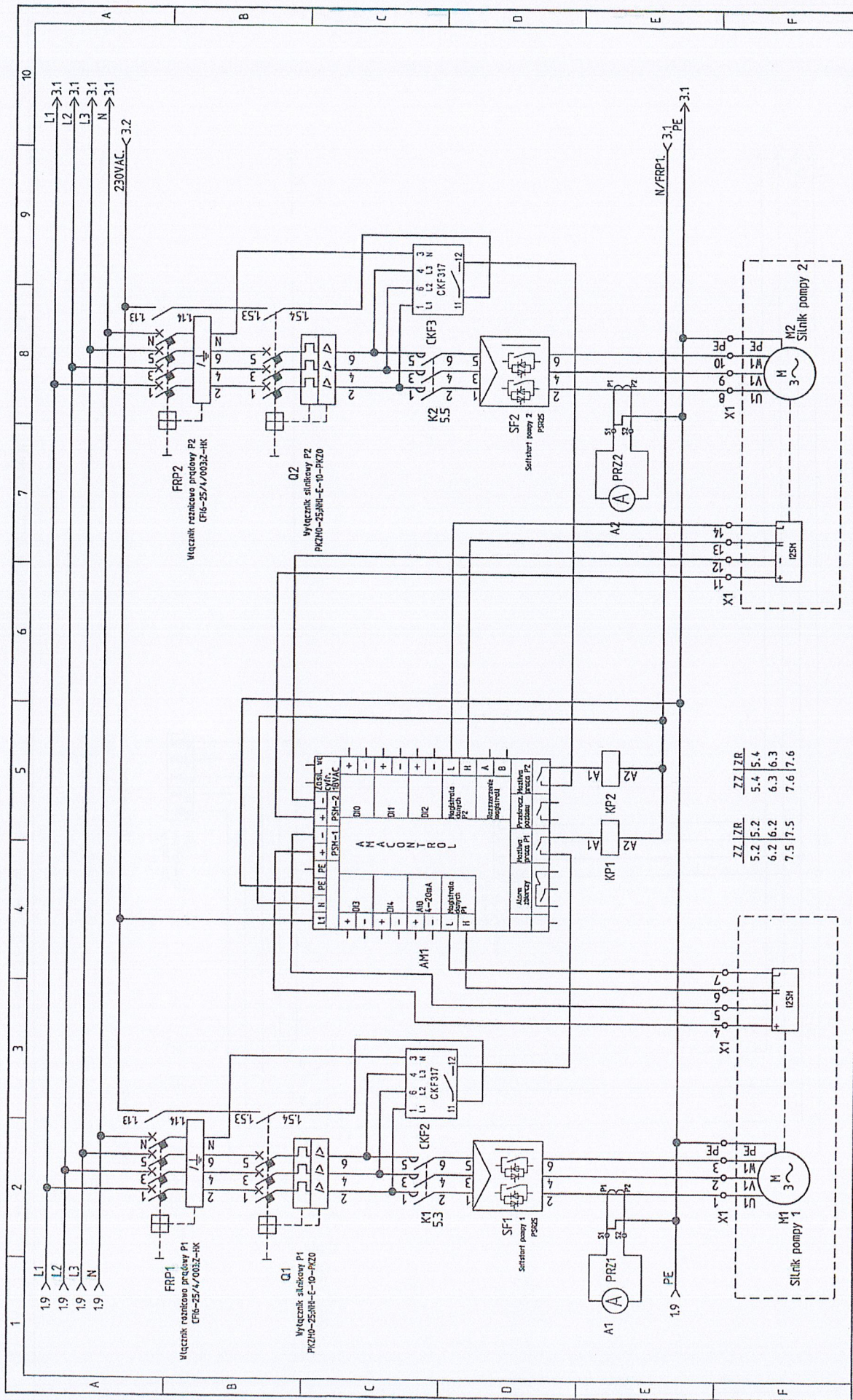

Projektant: Jerzy Cholewiński	Lb. sch: 10	Schemat: 2
Projekty: Tczew MT-101 2x10kW	Data: 2017-03-14	Sch. nast: 3
Temat strony: Obwody główne		

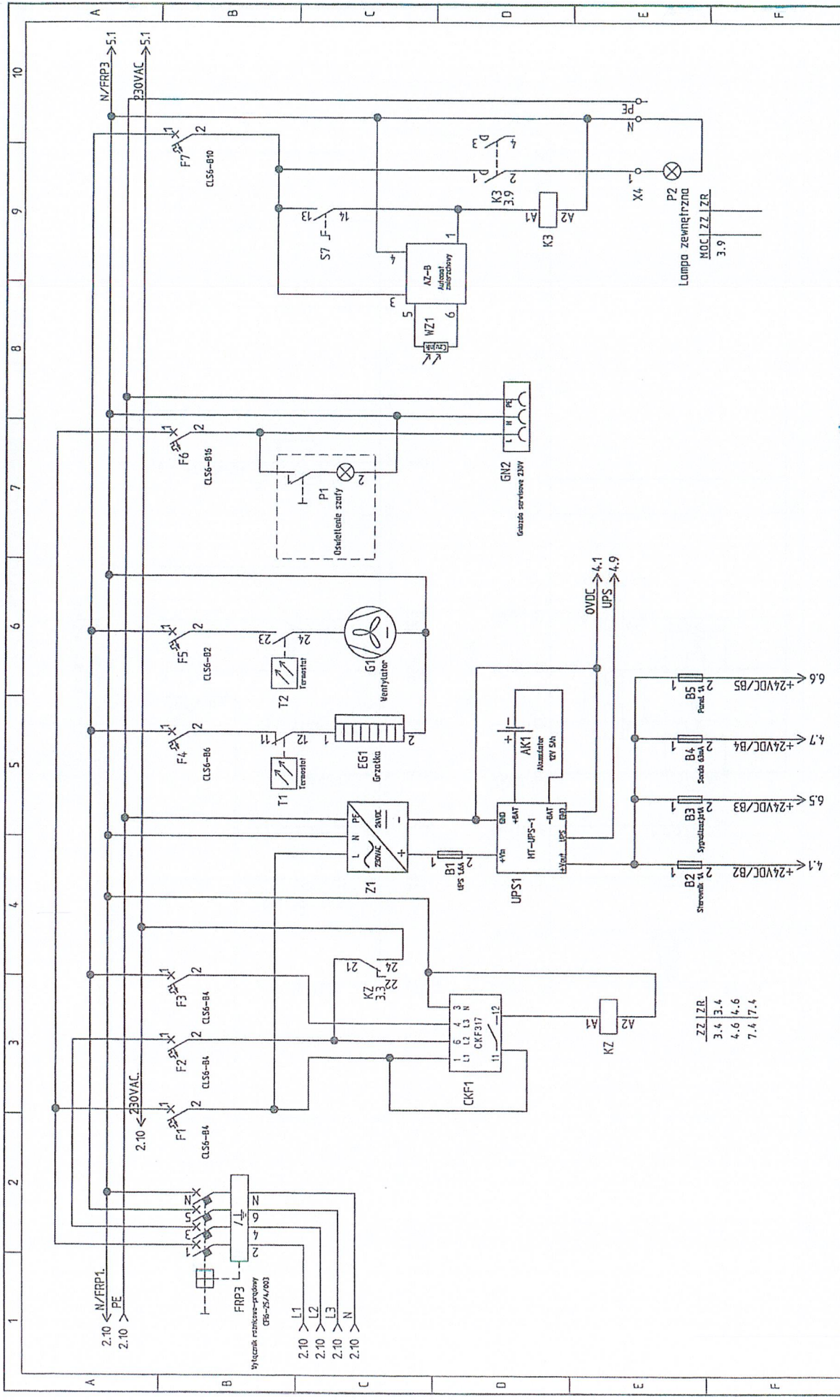

Projekt:	Tczew MT-101 2x10kW	Projektant:	Jerzy Cholewiński	Lb. sch.:	10	Schemat:	3
Temat strony:	Obwody pomocnicze	Data:	2017-03-14	Sch. nast:	4		

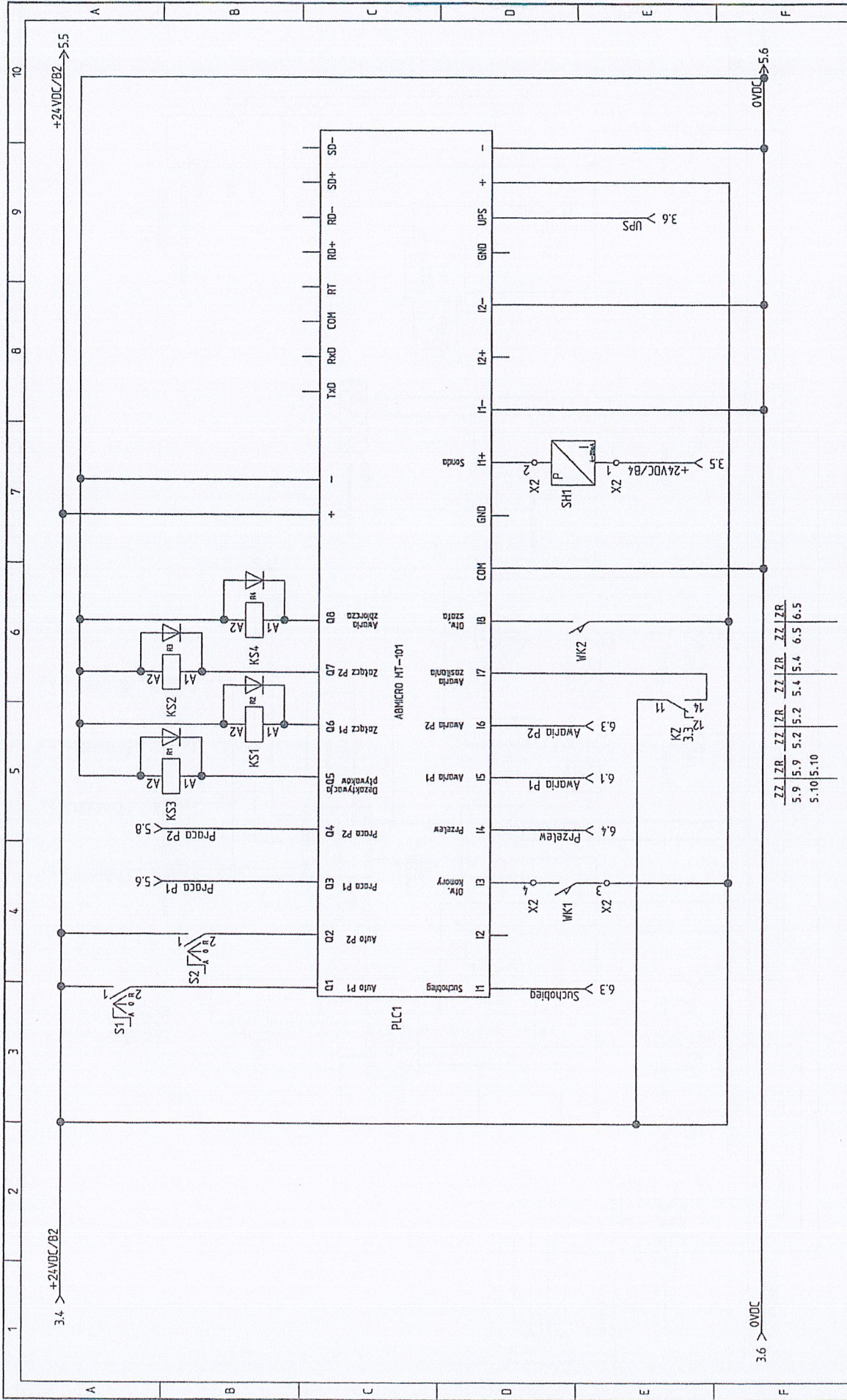

Projekt:	Tczew MT-101 2x10kW	Projektant:	Jerzy Cholewiński	Lb. sch.:	10	Schemat:	4
Temat strony:	Sterownik PLC	Data:	2017-03-14	Sch. nasti:	5		

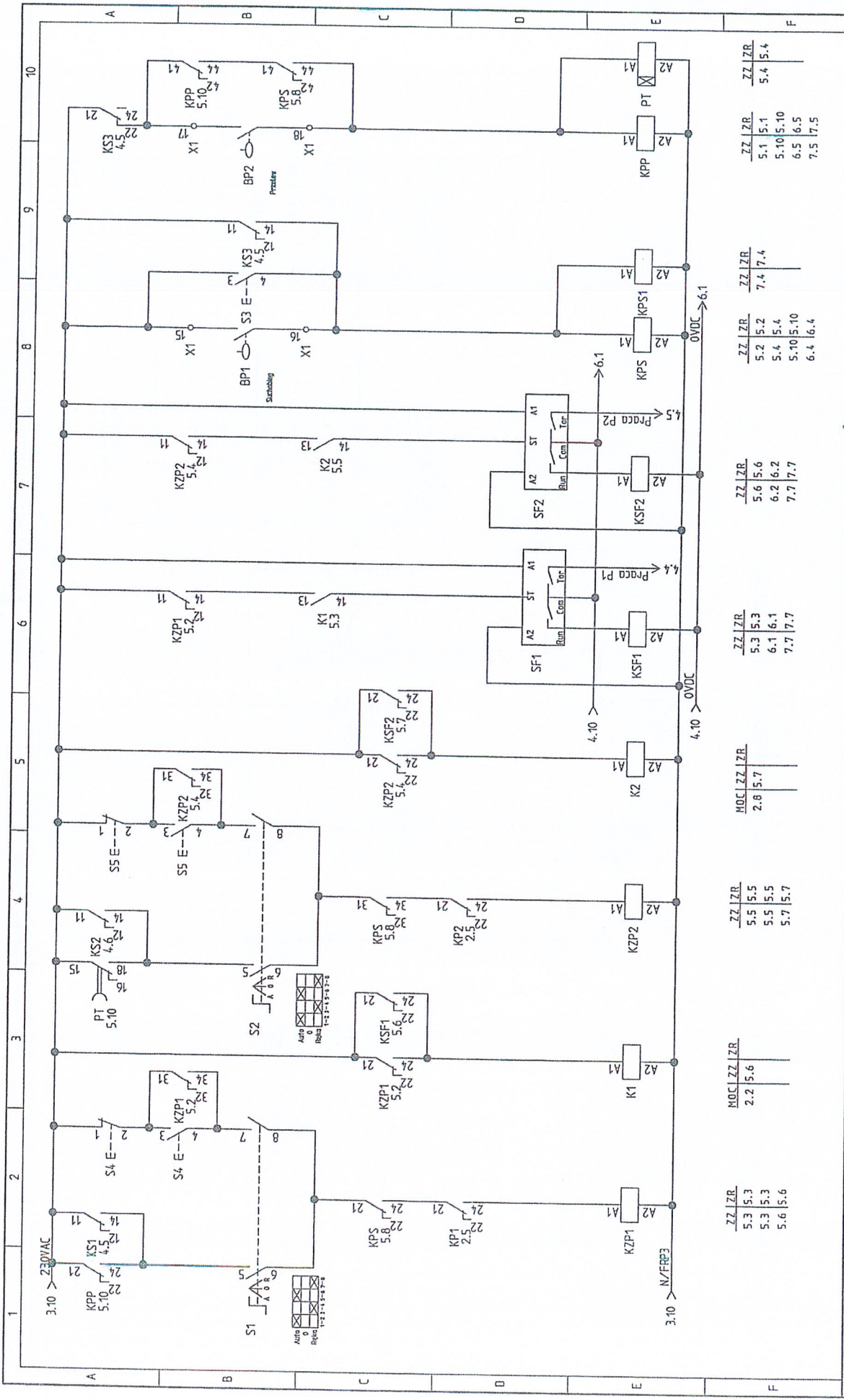

Projekti:	Tczew MT-101 2x10kW	Projektant: Jerzy Cholewiński	Lb. schi:	10	Schemat:	5
Temat strony:	Sterowanie i sygnalizacja poziomów		Data:	2017-03-14	Sch. nasti:	6

Handwritten signature

ZZ ZR	5.3 5.3	MOC ZZ ZR	2.2 5.6	ZZ ZR	5.1 5.1	ZZ ZR	5.4 5.4
ZZ ZR	5.3 5.3	MOC ZZ ZR	2.2 5.6	ZZ ZR	5.10 5.10	ZZ ZR	5.4 5.4
ZZ ZR	5.6 5.6	MOC ZZ ZR	2.8 5.7	ZZ ZR	6.5 6.5	ZZ ZR	7.5 7.5
ZZ ZR	5.5 5.5	MOC ZZ ZR	2.8 5.7	ZZ ZR	6.4 6.4	ZZ ZR	7.4 7.4
ZZ ZR	5.7 5.7	MOC ZZ ZR	2.8 5.7	ZZ ZR	5.10 5.10	ZZ ZR	5.10 5.10
ZZ ZR	5.5 5.5	MOC ZZ ZR	2.8 5.7	ZZ ZR	6.4 6.4	ZZ ZR	7.4 7.4
ZZ ZR	5.7 5.7	MOC ZZ ZR	2.8 5.7	ZZ ZR	5.10 5.10	ZZ ZR	5.10 5.10
ZZ ZR	5.5 5.5	MOC ZZ ZR	2.8 5.7	ZZ ZR	6.4 6.4	ZZ ZR	7.4 7.4

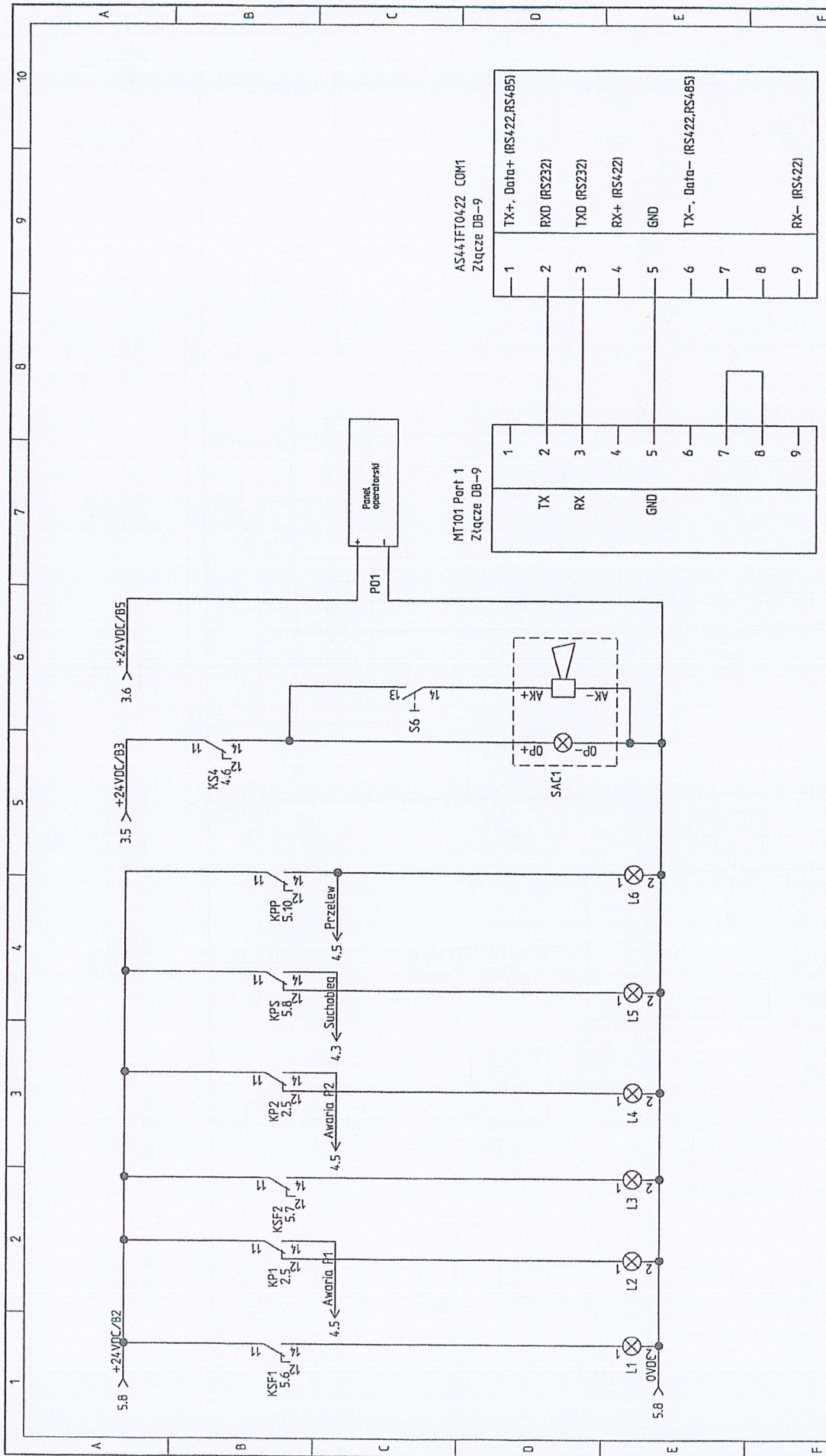

Projekt: Tczew MT-101 2x10kW		Projektant: Jerzy Cholewiński		Lb. schi: 10		Schemat: 6	
Temat strony: Modem		Data: 2017-03-14		Sch. nasti: 7			

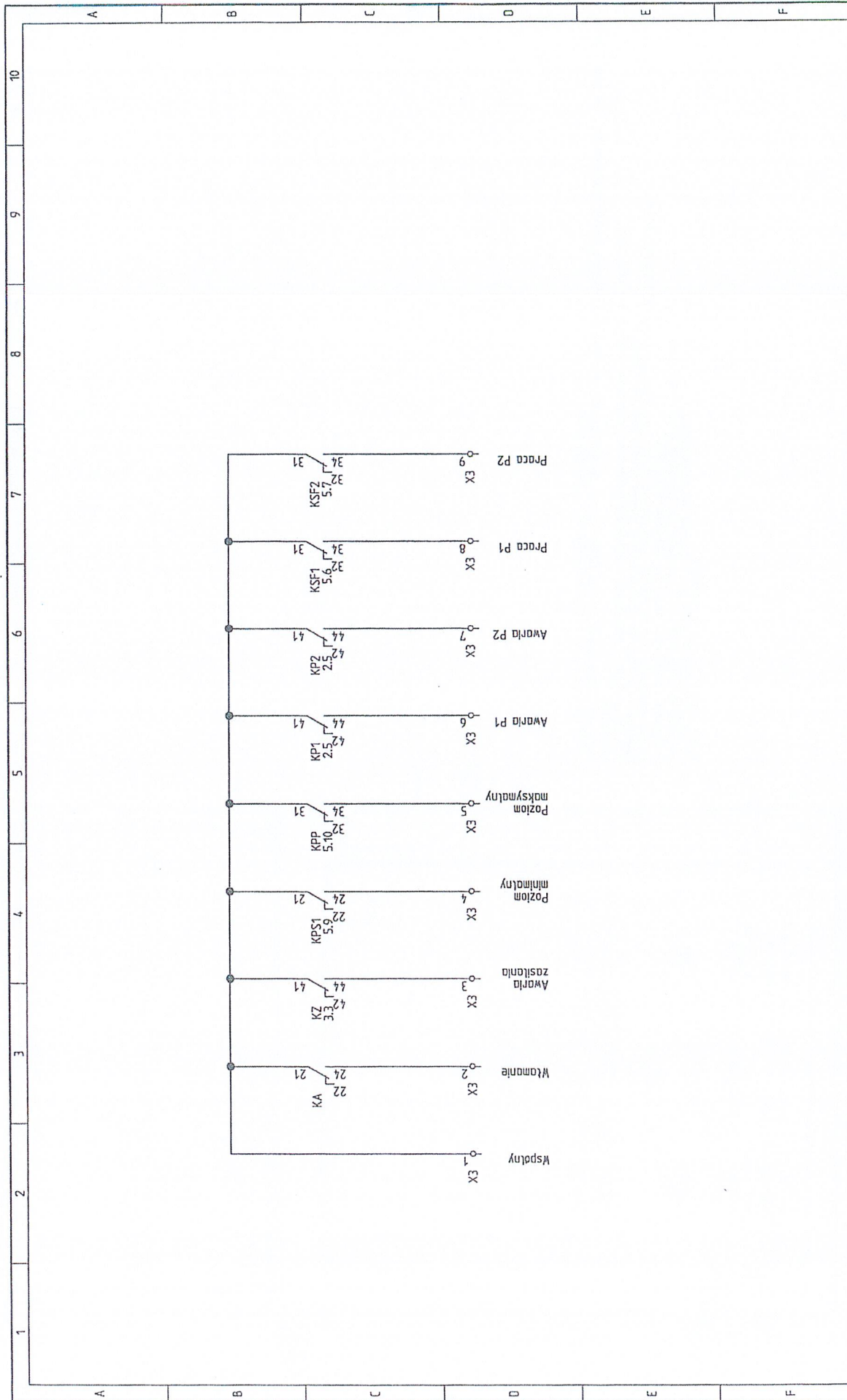

Projekt:	Tczew MT-101 2x10kW			Lb. sch:	10	Schemat:	7
	Temat strony:				Data:		Sch. nast:
			Projektant: Jerzy Cholewiński				8
			Styki bezpotencjalowe		2017-03-14		

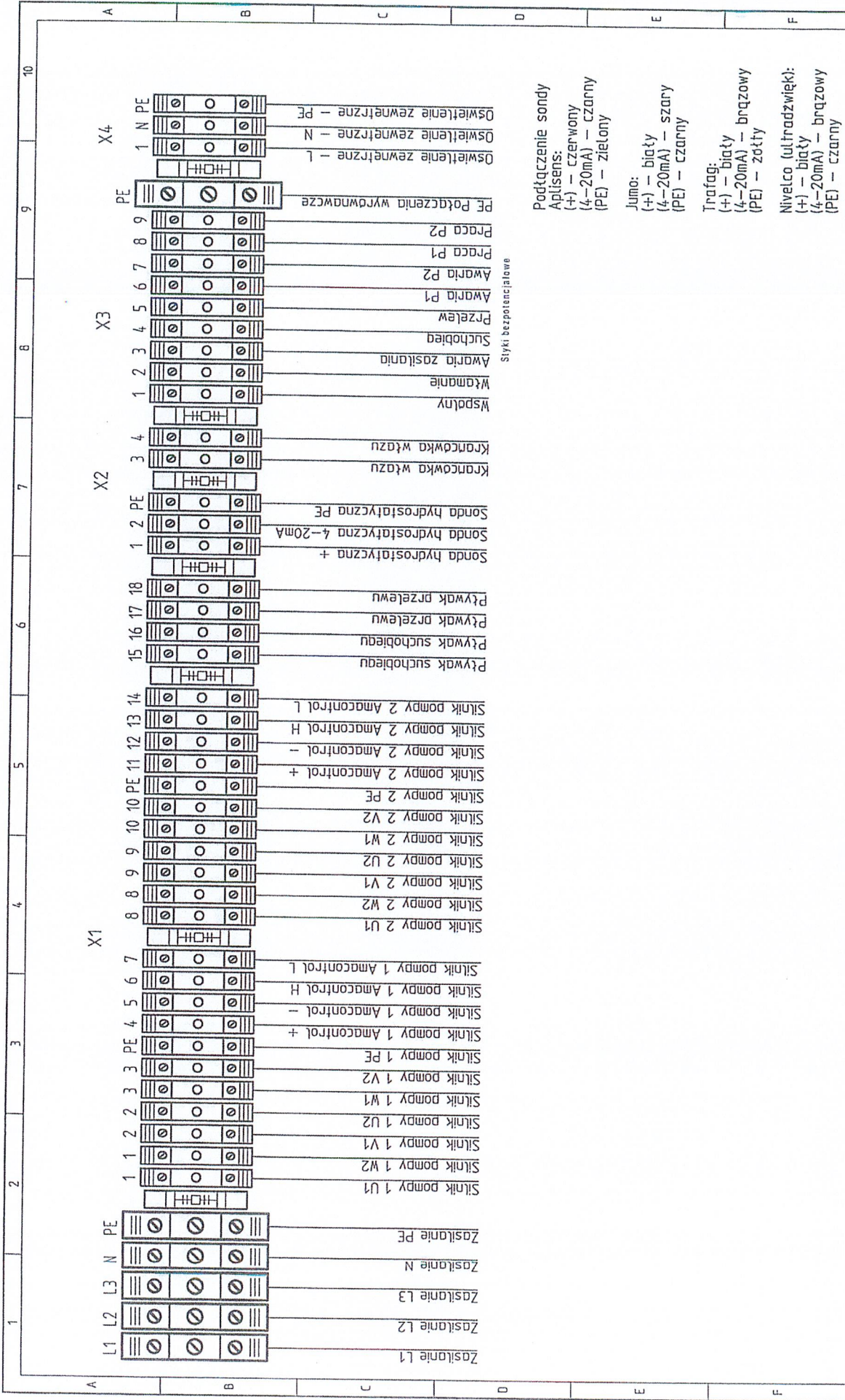

Sytki bezpotencjalowe

Podłączenie sondy
 Aplisens:
 (+) – czerwony
 (4-20mA) – czarny
 (PE) – zielony

Jumo:
 (+) – biały
 (4-20mA) – szary
 (PE) – czarny

Trafag:
 (+) – biały
 (4-20mA) – brązowy
 (PE) – żółty

Nivelco (ultradźwięk):
 (+) – biały
 (4-20mA) – brązowy
 (PE) – czarny

Projektant: Jerzy Cholewiński	Lb. sch.: 10	Schemat: 9
Projekt: Tczew MT-101 2x10KW	Data: 2017-03-14	Sch. nast: 9
Temat strony: Listwy zaciskowe		